

# VIRTUO

**Fast. Precise. Compact.**  
Automatic Packing Solution

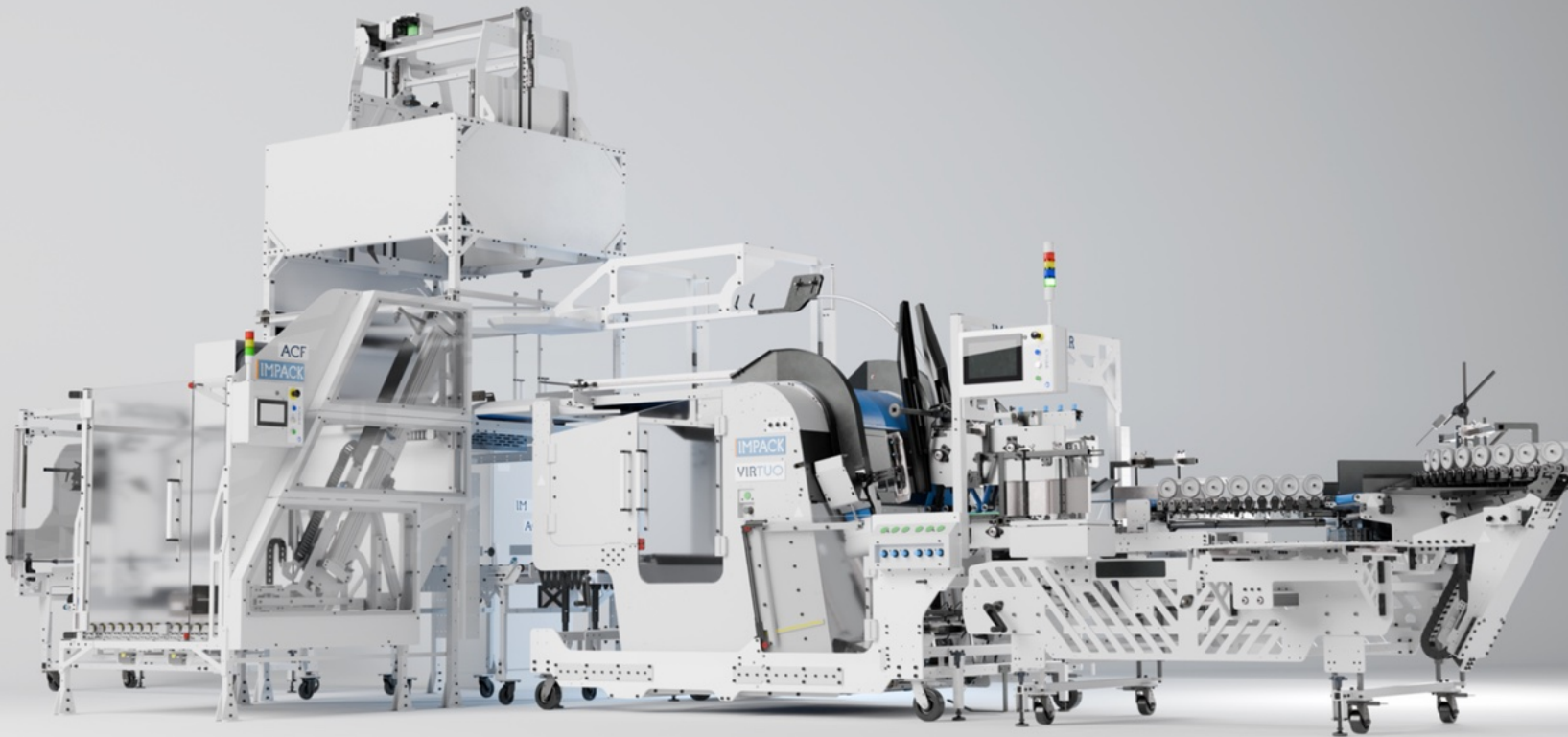

## Advantages

### Maximum Speed & Productivity

Ultra high speed packing of heavy boxes.

### Versatility in Packaging

Handles folding-carton and corrugated rectangular-shaped boxes with ease.

### Optimized for Larger Boxes

Perfect for medium to large straight-line boxes, such as beverage packs, cat litter containers, and dry detergent packaging.

**IMPACK**

Folder-Gluer Peripherals  
**Speed. Efficiency. Productivity.**

For more information contact your IMPACK Sales Representative.

+1 450 839 7272.

[sales@impack.ca](mailto:sales@impack.ca).

[www.impack.ca](http://www.impack.ca)

v2501.en



# VIRTUO

Semi-Automatic Packing Solution

## Common Configurations

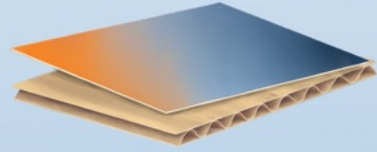

### Standard Configuration

\$325,000 USD\*

Manual case feeding, automatic box turning and packing

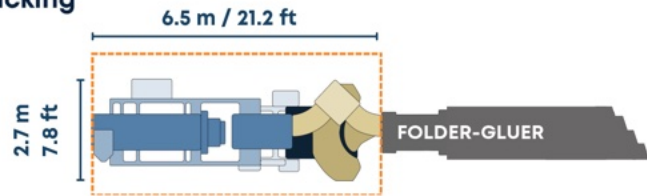
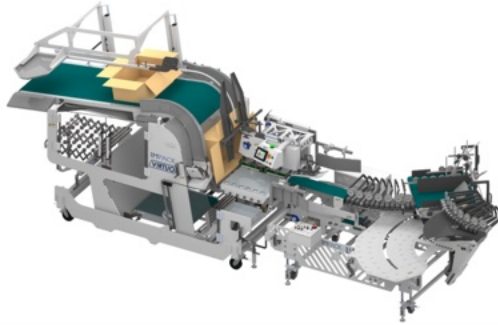

### Fully Automatic Configuration

\$530,000 USD\*

Includes automatic case feeder, automatic flap folder

Optional Automatic Flap Opener  
+\$70,000

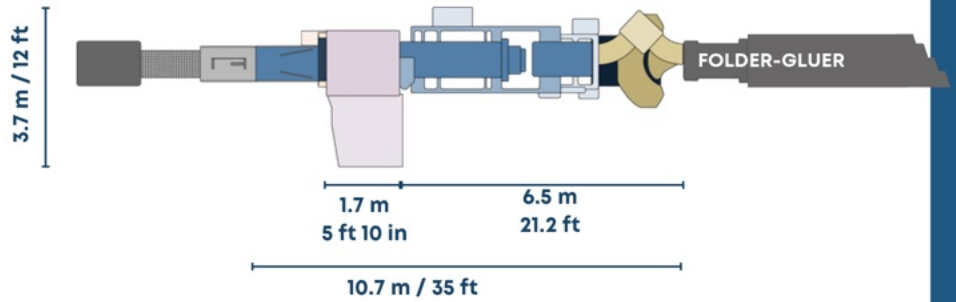
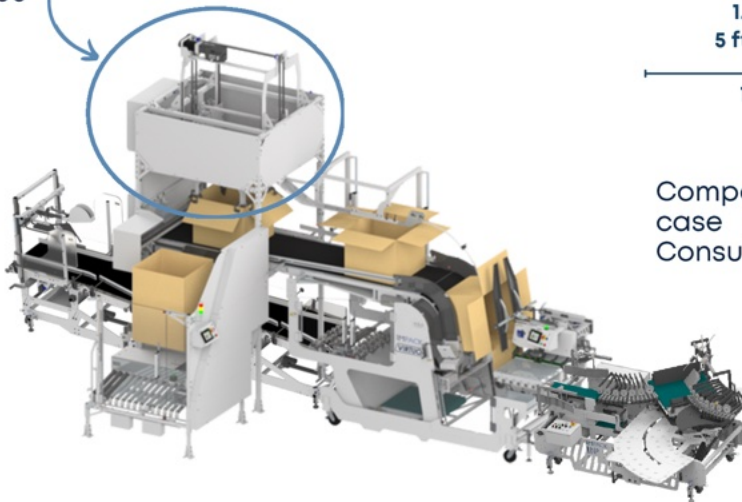

Compatible with 3rd-party case forming, case sealing and palletization solutions. Consult with your IMPACK Sales Manager.

Pairing with PREFIO Folder-Gluer Pre-feeder highly recommended. PREFIO: \$65,500 USD\*



Folder-Gluer Peripherals  
**Speed. Efficiency. Productivity.**

For more information contact your IMPACK Sales Representative.

+1 450 839 7272.

sales@impack.ca.

[www.impack.ca](http://www.impack.ca)

\*Pricing is approximate and subject to change, contact your regional sales manager for a personalized quote.

v2501.en

VIRTUO

# VIRTUO

**Fast. Precise. Compact.**

Automatic Packing Solution

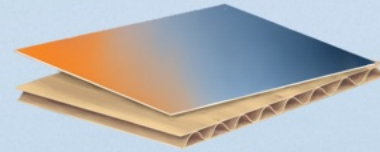

**Starter Configuration**

**\$325,000 USD\***

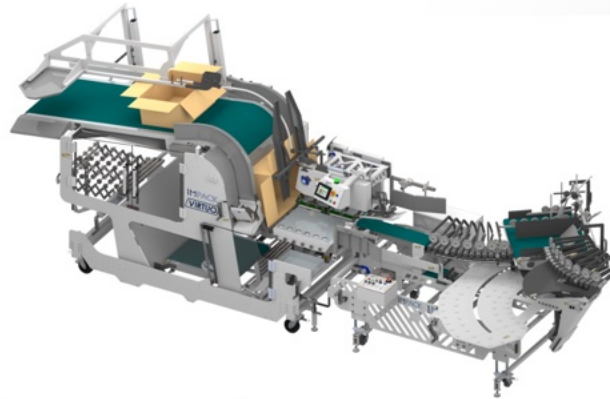

**PAYBACK**  
LESS THAN 2 YEAR



**+50-100%**



**Up to 8 Cases  
per Minute**



**5-15 Minute  
Changeovers**



**COMPETITIVE  
ADVANTAGE**

High speed packing of folding-carton AND corrugated packaging.



- Optimized for folding carton and corrugated rectangular shaped boxes
- Medium to large straight-line boxes, i.e., large beverage, cat litter boxes, dry detergent and dish washer capsule boxes
- Can also run small to medium straight-line boxes, but these may be better packed on an ERGOSA with an INH. Ask your sales representative for advice.



- Some 4/6 corner and basket beverage carriers can be packed on the Virtuo
- Some boxes have features that cause interlocking, i.e., handles or windows - testing will determine if these boxes are compatible with the system



- Autobotom boxes cannot be packed on the VIRTUO.



## Single Row Single Layer Case Configurations

\*Pricing is approximate and subject to change, contact your area sales manager for a personalized quote. Actual productivity and time to payback depend on many factors unique to each client.



# VIRTUO

## Automatic Packing Solution

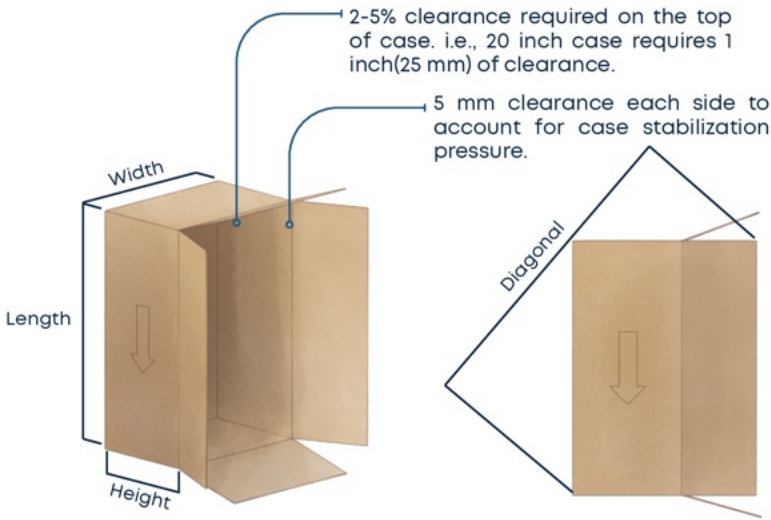
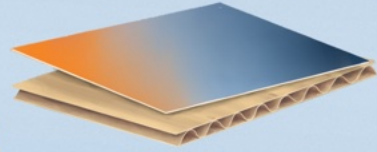

### CASE DIMENSIONS

Width	Min.	200 mm / 8 in
	Max.	750 mm / 29.5 in
Length	Min.	255 mm / 10 in
	Max.	840 mm / 33 in
Height	Min.	205 mm / 8 in
	Max.	545 mm / 21.5 in
Diagonal	Max.	900 mm / 35.5 in

Open top cases(HSC) or standard cases with flaps (RSC)

Other case dimensions are possible upon analysis. Reach out to your regional sales manager for an analysis.

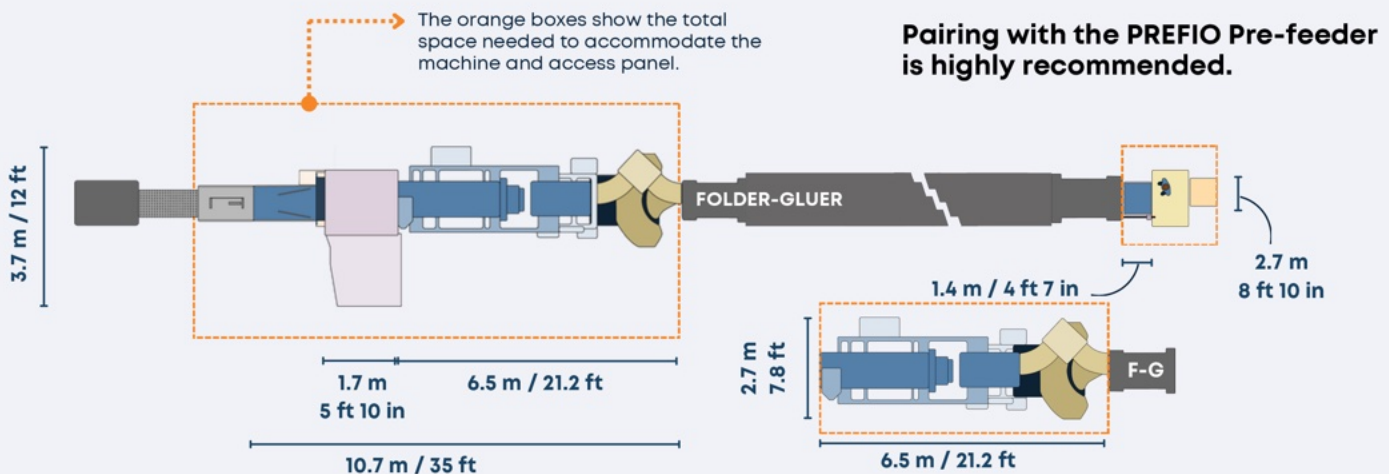

Pairing with the PREFIO Pre-feeder is highly recommended.



Folder-Gluer Peripherals  
**Speed. Efficiency. Productivity.**

For more information contact your IMPACK Sales Representative.  
 +1 450 839 7272. sales@impack.ca. [www.impact.ca](http://www.impact.ca)



Visit [product page](http://product.page)